

2'7"

2'

1'59"

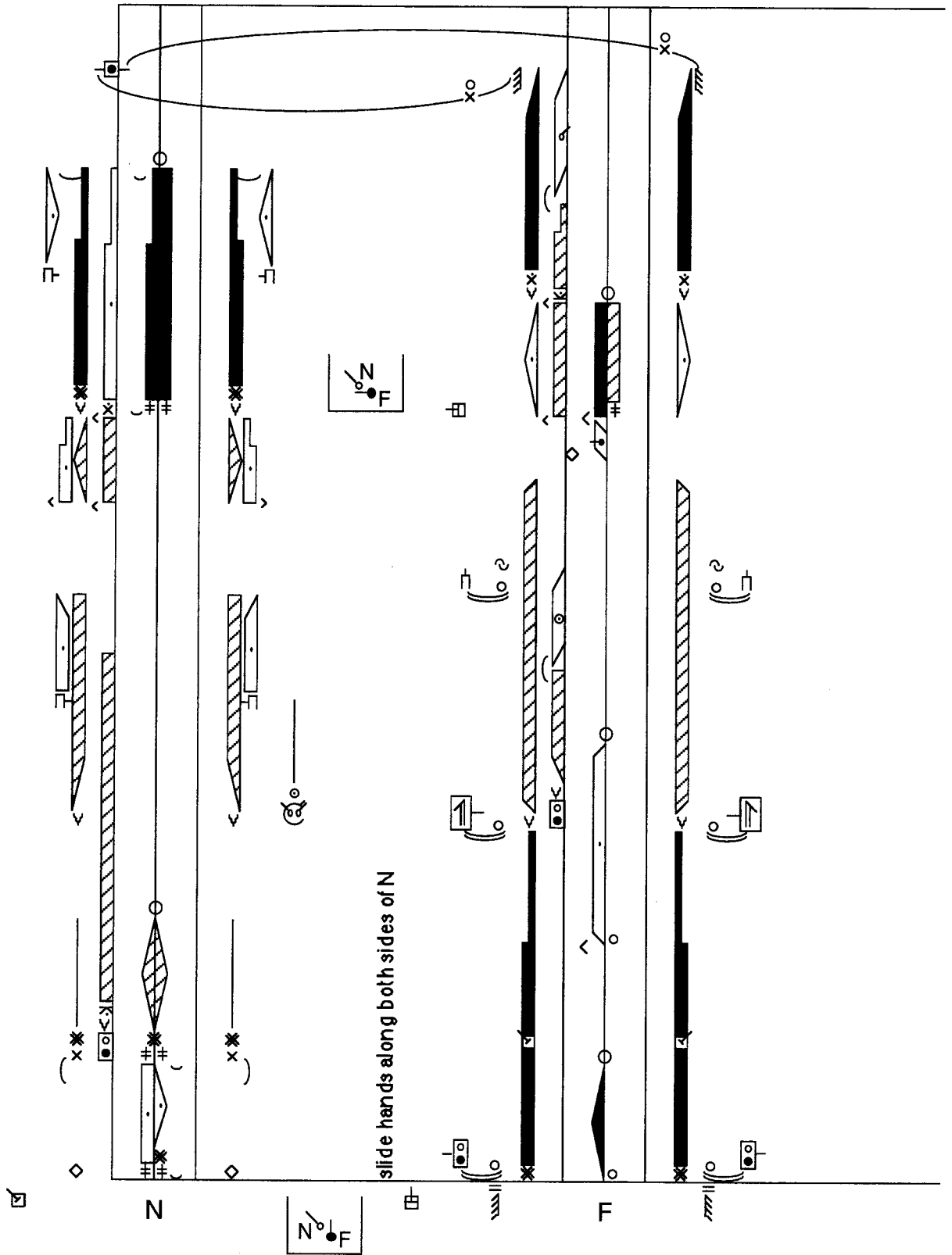

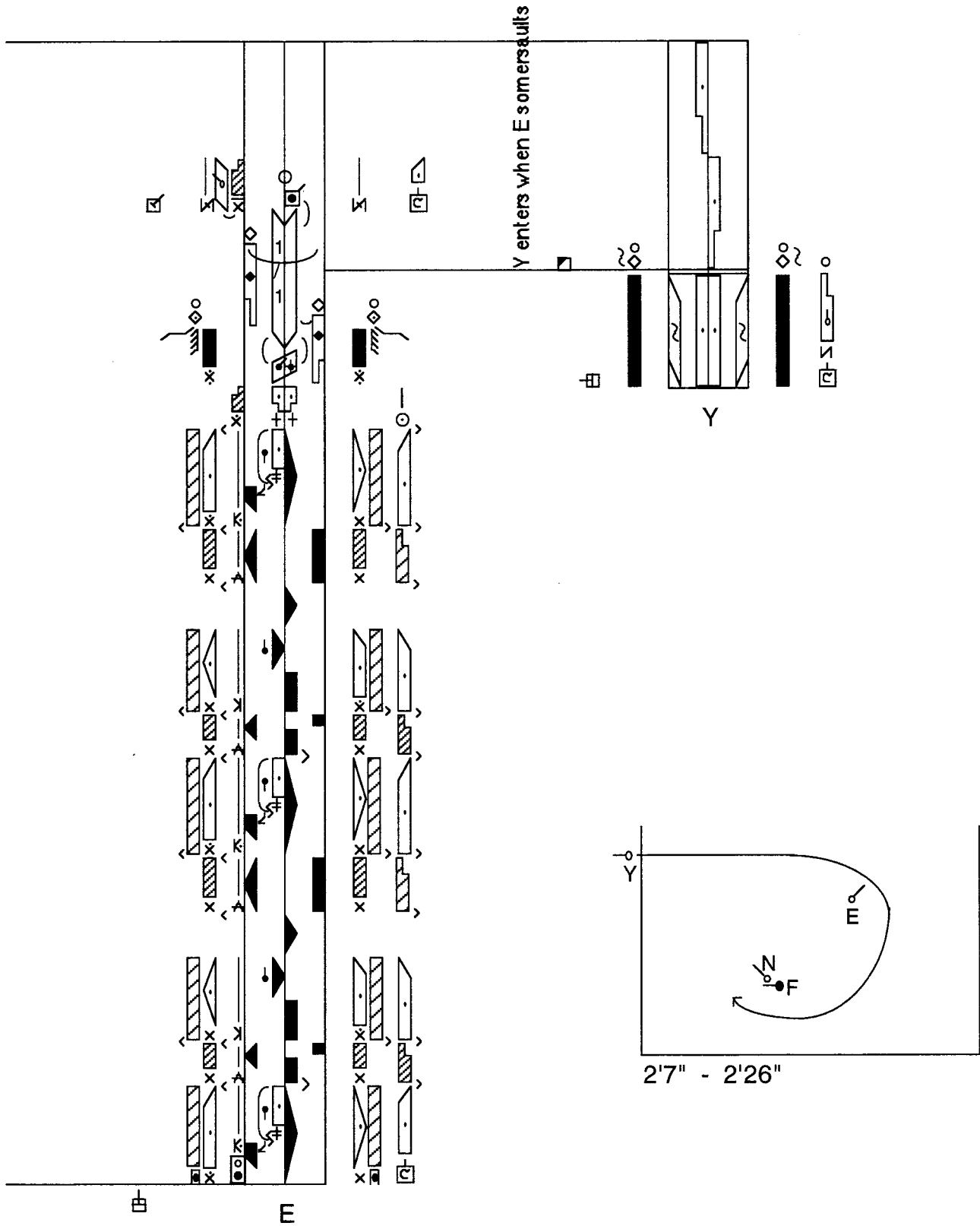

2'9"

N & F hug each other

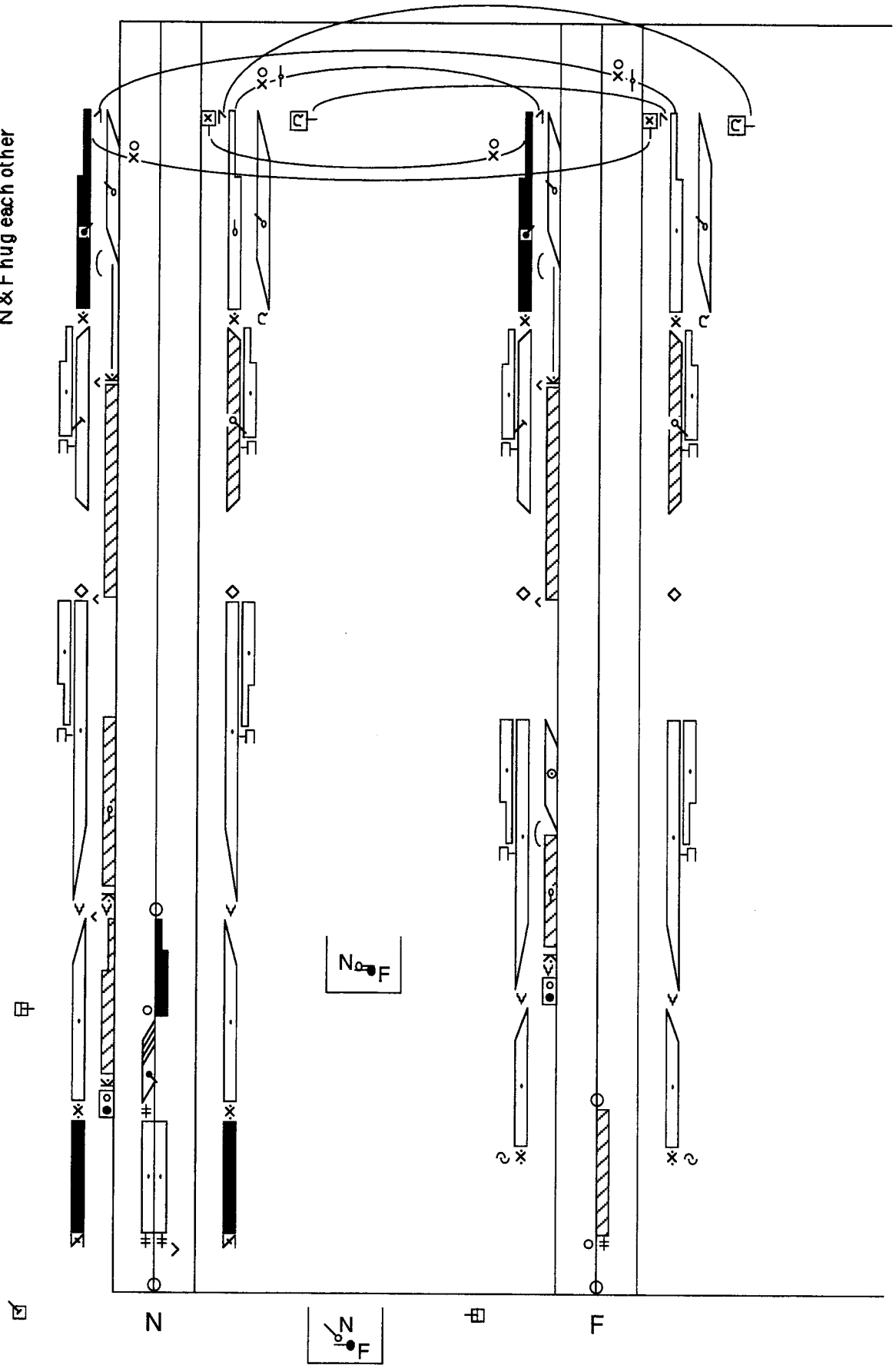

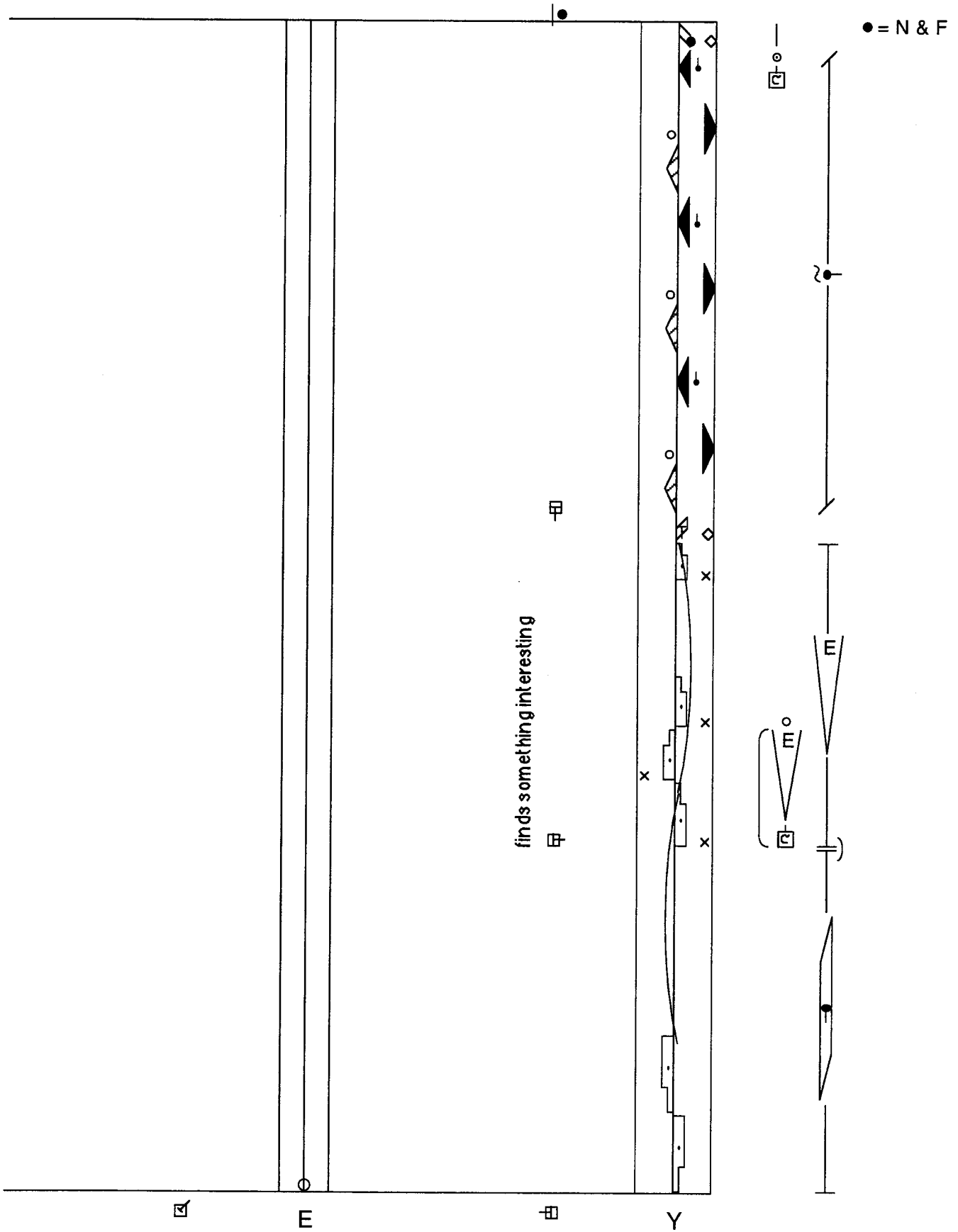

2'27"

2'20"

[Head Stand]

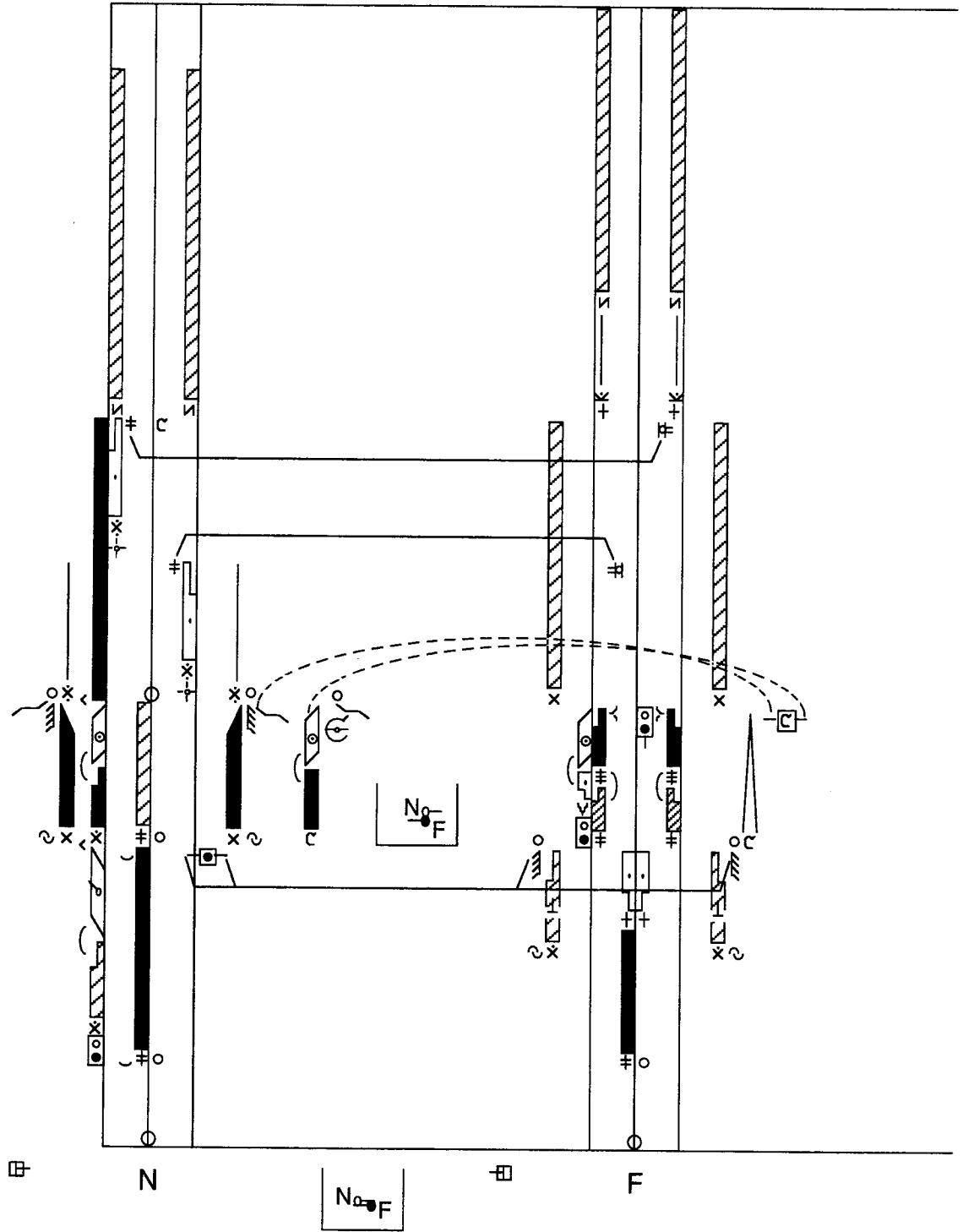

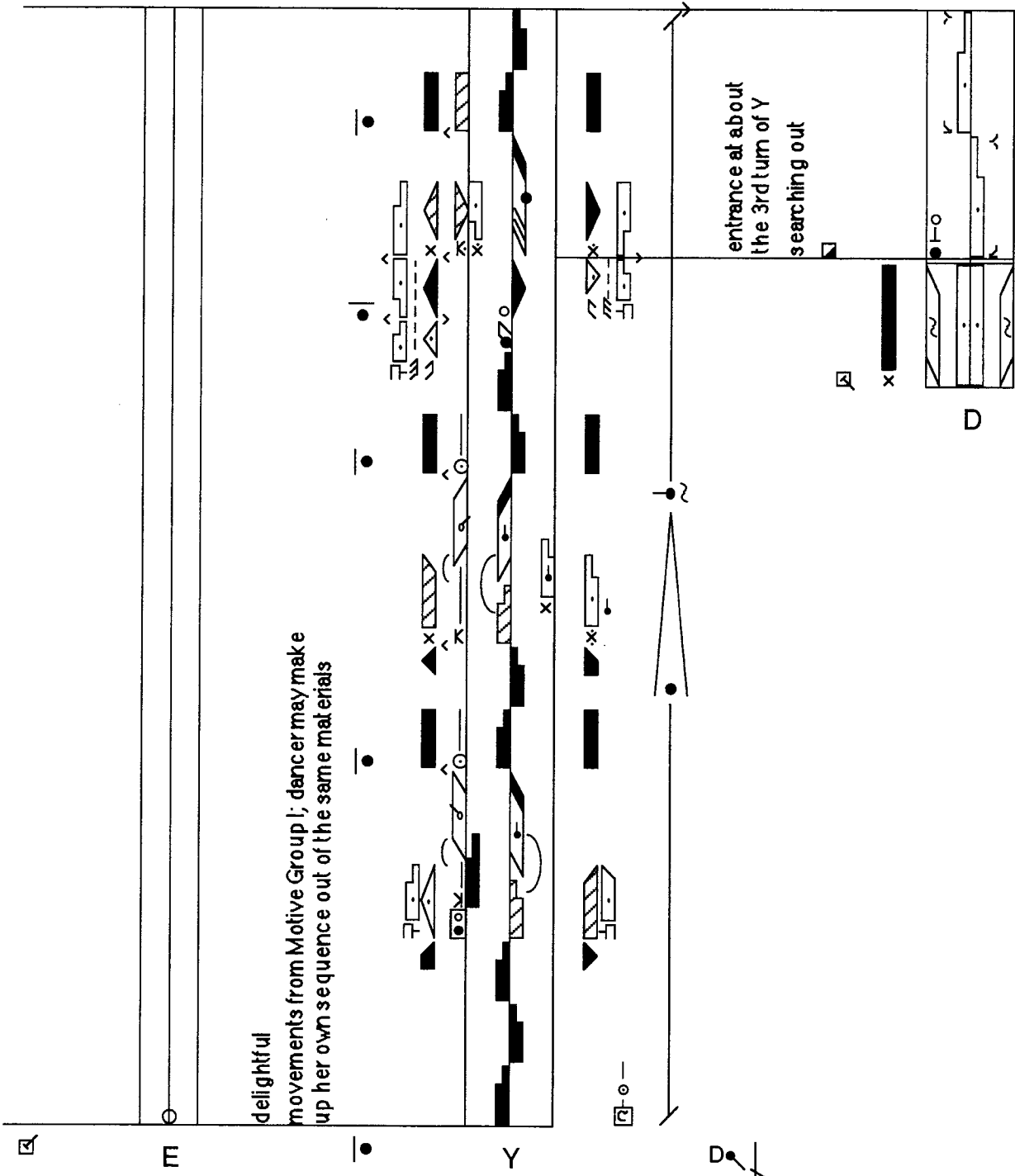

delightful
 movements from Motive Group I; dancer may make
 up her own sequence out of the same materials

see Glossary for
 Motive Group I

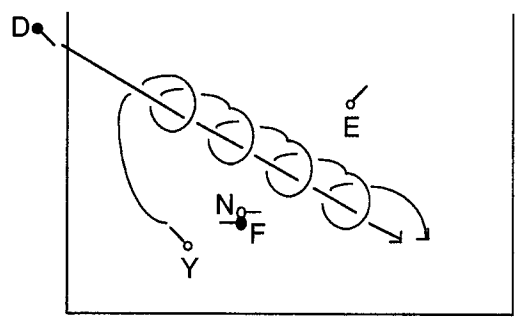

2'27" - 2'42"